

# BuzziCube 3D

## Product Specification Sheet

---

This document contains technical information about the BuzziCube 3D Solo, Duo, Trio, Quatro, L Right, L Left, T

---



[www.buzzi.space](http://www.buzzi.space)



## Sound absorbing 3D pouf

A high-design pouf that is unique in its class thanks to its revolutionary form and high-tech production process. The 3D foam covered with a variety of BuzziSpace fabrics gives it a unique touch.

Design by BuzziSpace Studio

---

## General

◆ BuzziCube 3D Solo, Duo, Trio, Quatro, L Right, L Left, T

Filling: Foam SG35,5

Cover: 3D foam CME35H

🌲 Upholstered in: Fabric, Rough, Trevira CS+, Memory 2

Pattern: 1 SQ, 4 SQ, 16 SQ

☁ Dry usage

🔑 Assembled

---

## Acoustics



Absorption



Diffusion

---

## Content

Configurations	3
Patterns	4
Components	4
Fabrics	5
Dimensions	7
Acoustics	8

# Configurations

## BuzziCube 3D

- ◆ Solo | Duo | Trio | Quatro | L Right | L Left | T
- ◆ 3D 1 SQ | 4 SQ | 16 SQ
- ◆ Bottom: antiskid, wood or with wheels (wheels only for Solo)
- ◆ Upholstery in Fabric, Rough, Trevira CS+, Memory 2

			<b>Antiskid</b>	<b>Wood</b>	<b>Wheels (only for Solo)</b>
✂	Solo:	L 50 cm L 19.69"	W 50 cm W 19.69"	H 47 cm H 18.50"	H 50 cm H 19.69"
	Duo:	L 94 cm L 37.01"	W 50 cm W 19.69"	H 47 cm H 18.50"	H 50 cm H 19.69"
	Trio:	L 138 cm L 54.33"	W 50 cm W 19.69"	H 47 cm H 18.50"	H 50 cm H 19.69"
	Quatro:	L 182 cm L 71.65"	W 50 cm W 19.69"	H 47 cm H 18.50"	H 50 cm H 19.69"
	L Left   Right:	L 138 cm L 54.33"	W 93 cm W 36.61"	H 47cm H 18.50"	H 50 cm H 19.69"
	T:	L 138 cm L 54.33"	W 93 cm W 36.61"	H 47 cm H 18.50"	H 50 cm H 19.69"

		<b>Antiskid</b>	<b>Wood</b>	<b>Wheels (only for Solo)</b>
⚖	Solo:	4 kg	8.82 lbs	Solo: 6 kg 13.23 lbs
	Duo:	7,5 kg	16.53 lbs	
	Trio:	11 kg	24.25 lbs	
	Quatro:	14,5 kg	31.97 lbs	
	L Left   Right:	14,5 kg	31.97 lbs	
	T:	14,5 kg	31.97 lbs	

**Solo**

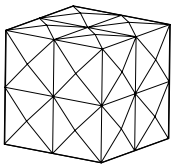

**Duo**

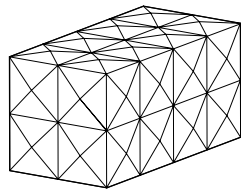

**Trio**

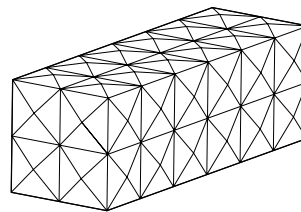

**Quatro**

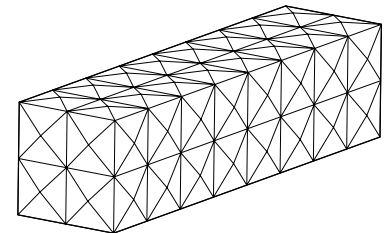

**L Left**

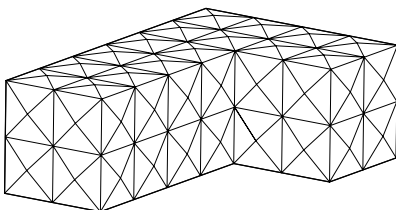

**L Right**

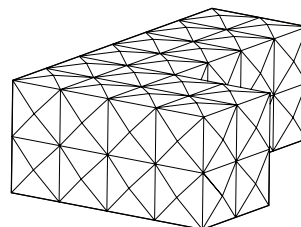

**T**

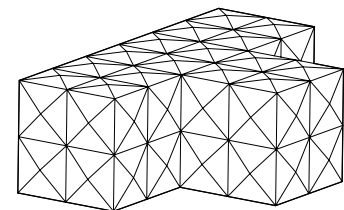

# Patterns

1 SQ

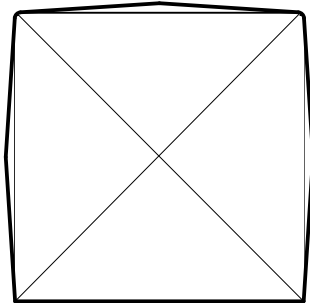

4 SQ

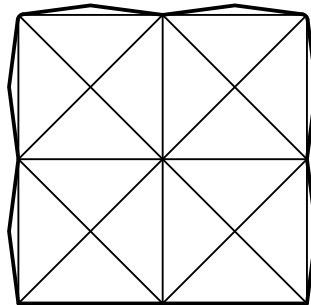

16 SQ

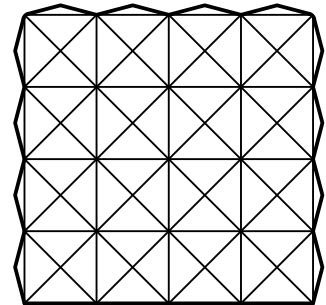

# Components

## Bottom

Antiskid

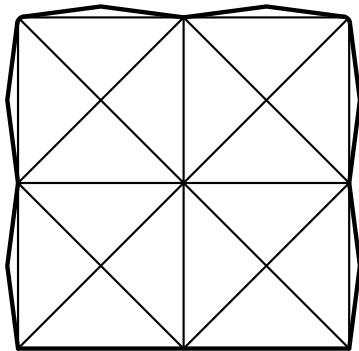

Bottom:  
Antiskid

Wood

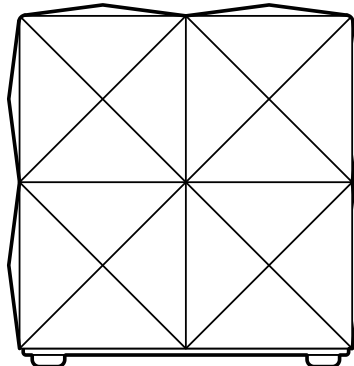

Bottom:  
Black MDF  
4 Plastic Feet

Wheels (only for Solo)

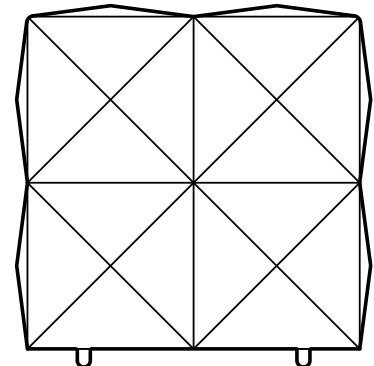

Bottom:  
Poplar multiplex  
MDF covered with antiskid  
4 Wheels  
(load capacity: 40 kg | 88.18 lbs  
per wheel)



# Fabrics

---

## Fabric



**Category A**

**Composition** 70% Recycled Wool, 25% Recycled Polyacryl,  
5% Recycled Other Fabrics

**Weight** 405 g/m<sup>2</sup> | 11.94 oz/yd<sup>2</sup>

**Abrasion resistance** 40.000 Martindale, 50,000 Wyzenbeek

**Flammability** EU: EN 1021.1/2006 | BS EN 1021.1/2006 (cigarette).  
EN 1021.2/2006 | BS EN 1021.2/2006 (match)  
USA: CAL TB 117 | ASTM E84 CLASS A

**Fastness to light** EU: 4 | USA 4

**Fastness to rubbing** EU: Wet 3-4 | Dry 4-5

**Fastness to crocking** USA: Wet 5 | Dry 5



## Rough

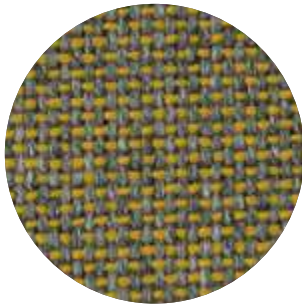

**Category A**

**Composition** 100% Polyacryl

**Weight** 456 g/m<sup>2</sup> | 13.45 oz/yd<sup>2</sup>

**Abrasion resistance** 40.000 Martindale

**Flammability** EU: EN 1021.1/2006 | BS EN 1021.1/2006 (cigarette)  
USA: CAL TB TB 117

**Fastness to light** EU: 5

**Fastness to rubbing** EU: Wet: 3 | Dry: 3



## Trevira CS+

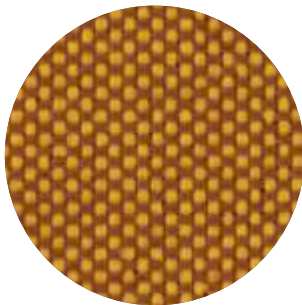

**Category A**

**Weight** 420 g/m<sup>2</sup> | 12.39 oz/yd<sup>2</sup>

**Composition** 100% Polyester, Trevira CS

**Abrasion resistance** 100.000 Martindale, 90,000 Wyzenbeek

**Flammability** BS 5852 part II: CRIB 5 | BS 7176 Medium Hazard  
USA: CAL TB 117 | M1 | B1 | EN 1021/1-2 | C1 |  
IMO Res. A652 (16)

**Fastness to light** EU: 6 | USA 5

**Fastness to rubbing** EU: Wet 4-5 | Dry 4-5

**Fastness to crocking** USA: Wet 5 | Dry 5





**Category** E

**Composition** 100% Trevira CS

**Weight** 700 g/lin.m

**Abrasion resistance**

35.000 rubs acc. to the Martindale method, EN ISO 12947

**Flammability** EN 1021-1/2 | DIN 4102 B1 | Önorm B1/Q1  
NF D 60 013 | NF P 92 507 M1 | UNI 9175 11M  
UNI 9177 classe 1 | US Cal. Tech. Bull. 117  
IMO A.652 (16)

**Fastness to light** Note 5-8, ISO 105-B02

**Fastness to rubbing** (ISO) dry 4-5, wet 4-5

**Pilling** Note 4, EN ISO 12945



# Dimensions

**Solo**

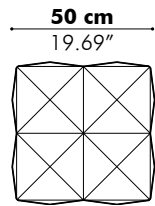

**Duo**

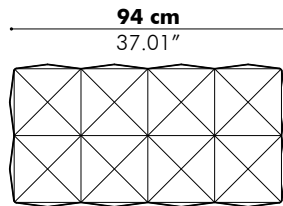

**Trio**

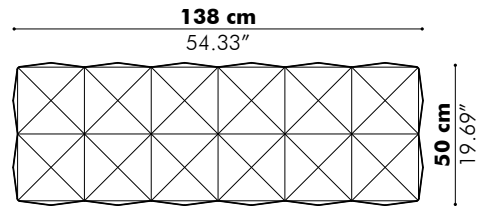

**Quatro**

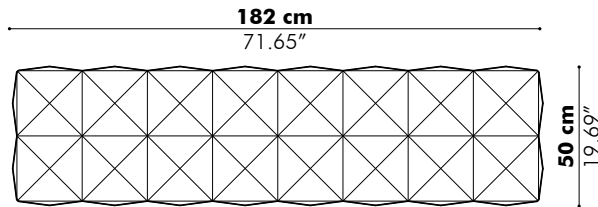

**L Left**

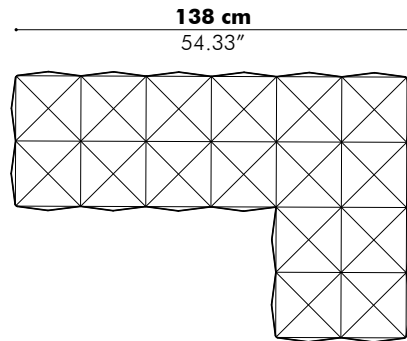

**L Right**

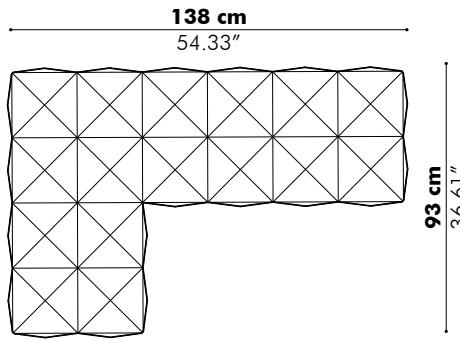

**T**

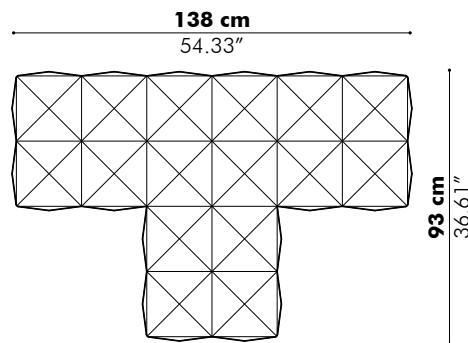

**Antiskid**

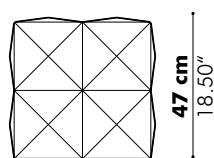

**Wood**

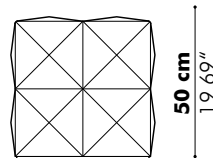

**Wheels**

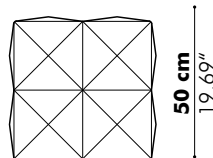

# Acoustics

## BuzziCube 3D

Equivalent sound absorption area in m<sup>2</sup> per object

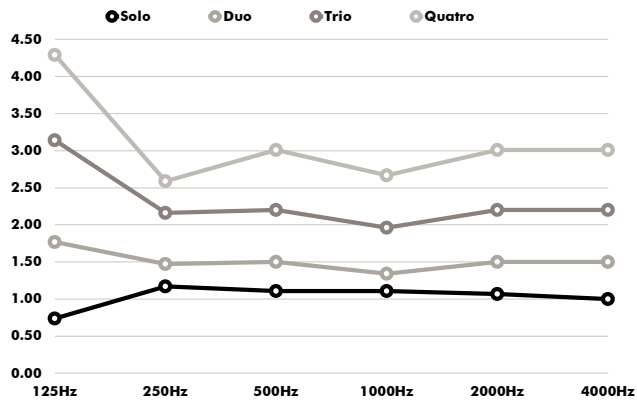

Hz	Solo Aeq/m <sup>2</sup>	Duo Aeq/m <sup>2</sup>	Trio Aeq/m <sup>2</sup>	Quatro Aeq/m <sup>2</sup>
125	1.06	1.77	3.14	4.29
250	0.88	1.47	2.16	2.59
500	0.90	1.50	2.20	3.01
1000	0.80	1.34	1.96	2.67
2000	0.90	1.50	2.20	3.01
4000	0.90	1.50	2.20	3.01